

➤ Instructions

Thule Mounting Bracket 901550

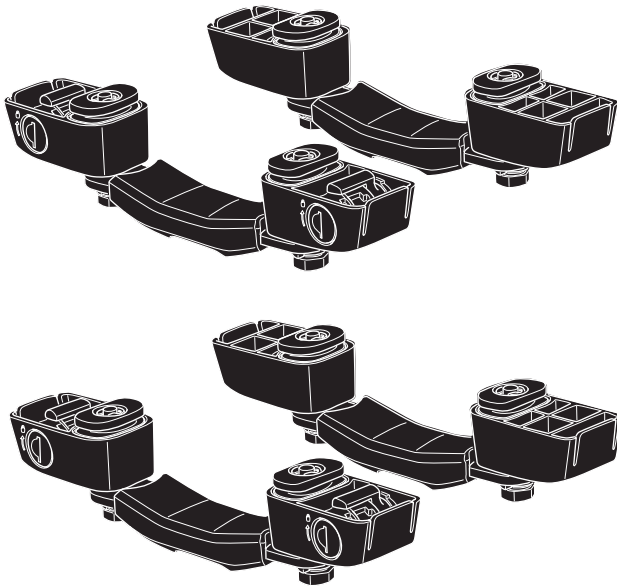

- EN** Mounting bracket for accessories on roof-mounted load carrier
- FR** Support de montage pour accessoires sur barre de toit
- ES** Soporte de montaje para accesorios de portaequipajes de techo
- DE** Halterung für Zubehör am Dachlastenträger
- NL** Montagebeugel voor accessoires voor op het dak gemonteerde dakdrager
- PT** Suporte para montagem de acessórios em racks automotivos de teto
- IT** Staffa di montaggio per accessori su portapacchi da tetto
- SV** Monteringsfäste för tillbehör på takmonterad lasthållare
- DK** Monteringsbeslag til tilbehør på tagmonteret lastholder
- NO** Monteringsbrakett for tilbehør på takmontert lastestativ
- FI** Varusteteline katolle asennettaviin kuljetuslaatikoihin
- IS** Festing fyrir aukahluti á farangursgrind á þak
- ET** Katuseraami tarvikute kinnituskamber
- LV** Stiprināšanas kronšteins piederumiem, kurus novieto uz jumta uzstādāmā turētāja
- LT** Laikiklis tvirtinti priedus prie ant stogo montuojamos bagažinės
- RU** Монтажная скоба для аксессуаров на багажник на крышу
- UK** Монтажний кронштейн для аксессуарів на багажник для даху
- PL** Wspornik mocujący do akcesoriów na bagażniku bazowym montowanym na dachu
- CS** Montážní držák pro příslušenství na montáž střešního nosiče
- HU** Rögzítőelem a tetőre szerelhető csomagszállító tartozékaihoz
- RO** Consolă de montare pentru accesorii pe suportul de transport montat pe acoperiș

- SK** Montážna konzola pre príslušenstvo na strešnom nosiči
- SL** Nosilec za dodatke na strešnem prtljažniku
- BG** Скоба за монтаж за аксесоари на товар в багажник, монтиран върху покрива
- HR** Montažni nosač za dodatnu opremu na krovnom nosaču tereta
- EL** Βραχίονας στερεώσεως αξεσουάρ στη σχάρα οροφής μεταφοράς φορτίου
- TR** Araç üstüne bağlanan yük taşıyıcısı üz erindeki aksesuarlar için montaj bağlantı parçası
- MT** Brekit tal-immuntar għall-accessorji fuq il-garrier tat-tagħbija mmuntat fuq is-saqaf

HE סוגר הרכבה לאבזרי ממשא הרכבה על הגג
AR تجهيز فتك التركيب للملحقات على نقل الحمولة المثبت على السطح

ZH (CN) 用于顶置货物托架配件的安装支架

ZH (TR) 安裝車頂荷重支架配件的托座

JA ルーフマウント型ロードキャリアのアクセサリ用マウンティングブラケット

KO 루프 장착형 로드 캐리어의 액세서리용 장착 브라켓

TH ขายึดอุปกรณ์เสริมสำหรับโครงยึดสิ่งของบนหลังคา

MS Pendakap pemasangan untuk aksesori pada pem bawa muatan yang dipasang di atas bumbung

CITY CRASH

Complies with ISO norm

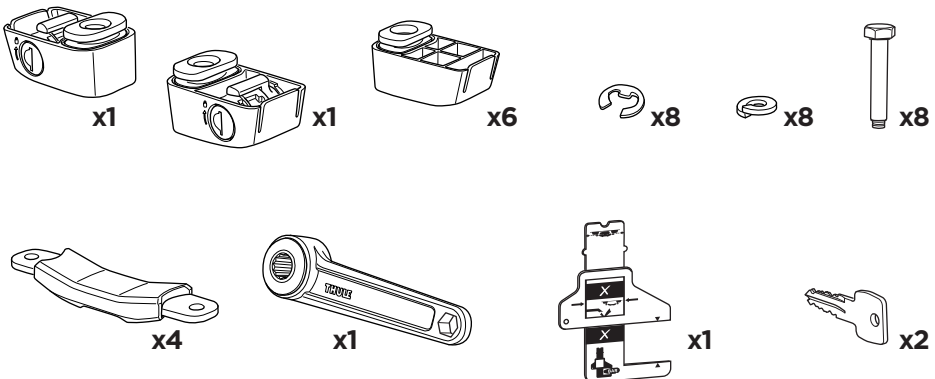
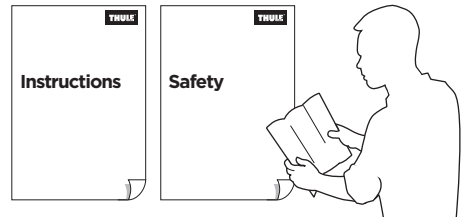

i



i

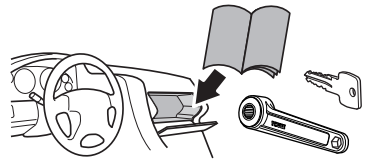

THULE
SlideBar Evo

THULE
TracRac



THULE
WingBar Evo

THULE
AeroBlade

THULE
Xsporter

THULE
ProBar Evo

THULE
SquareBar Evo

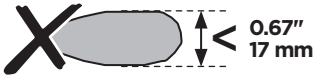
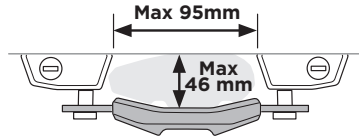
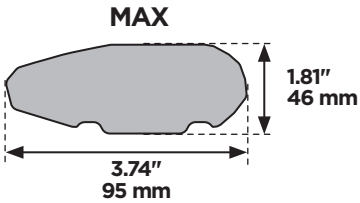
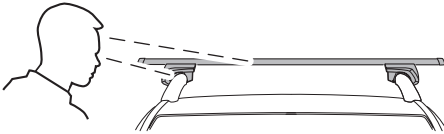

Not ok

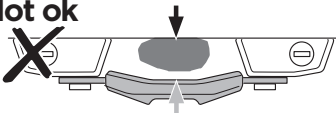

ok

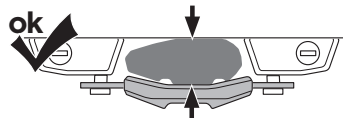

> Video Instructions

Thule Mounting Bracket



thule.com

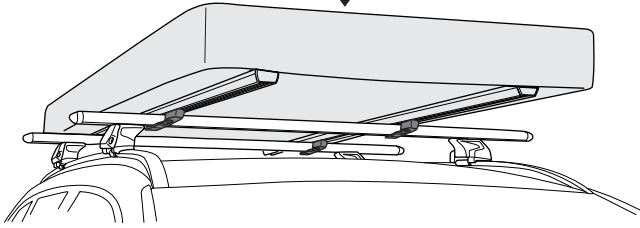

i

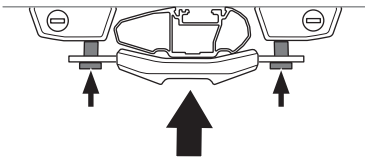

Alt I

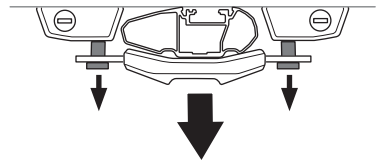
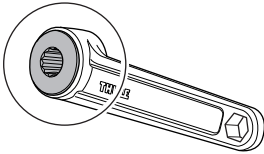

Alt II

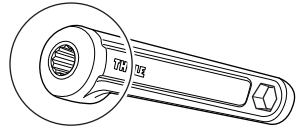

i

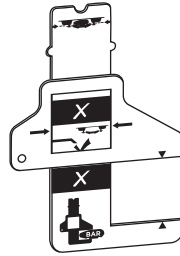
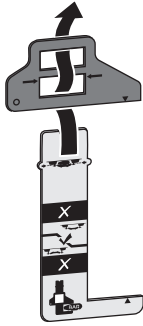

1

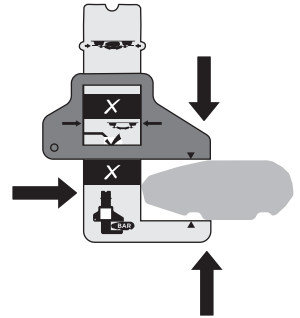
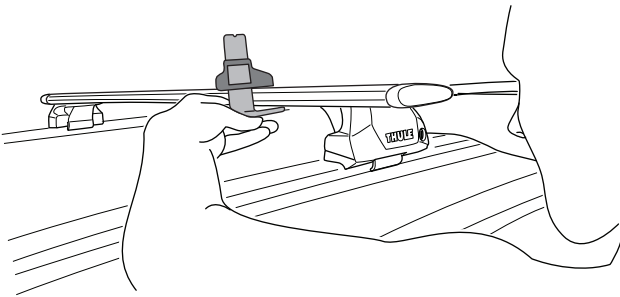

Fit ok
✓

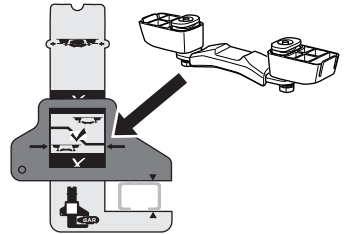
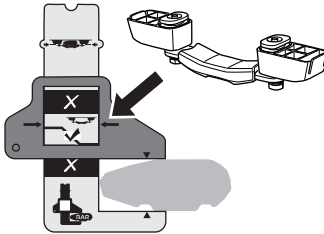

Fit Not ok
✗

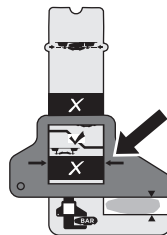
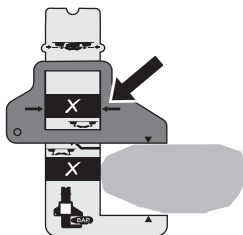

2

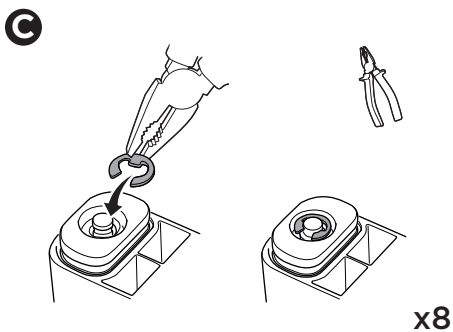
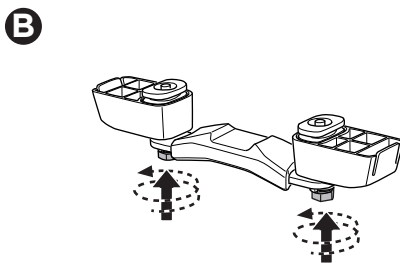
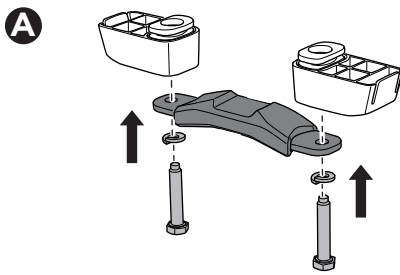
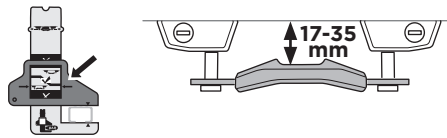
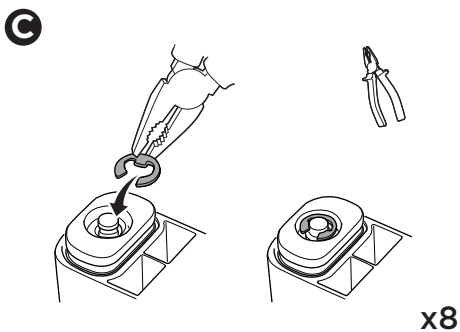
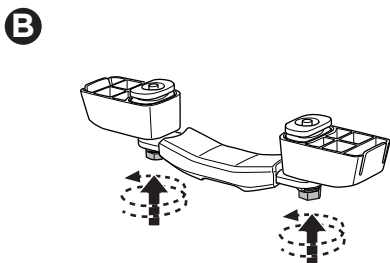
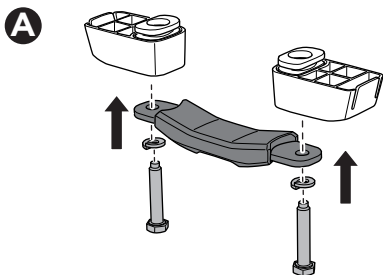
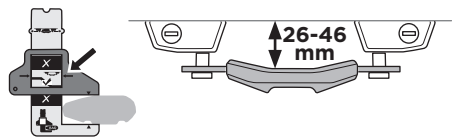

ok ✓

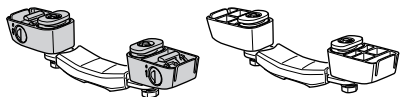

Not ok ✗

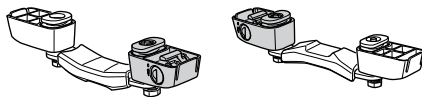

3

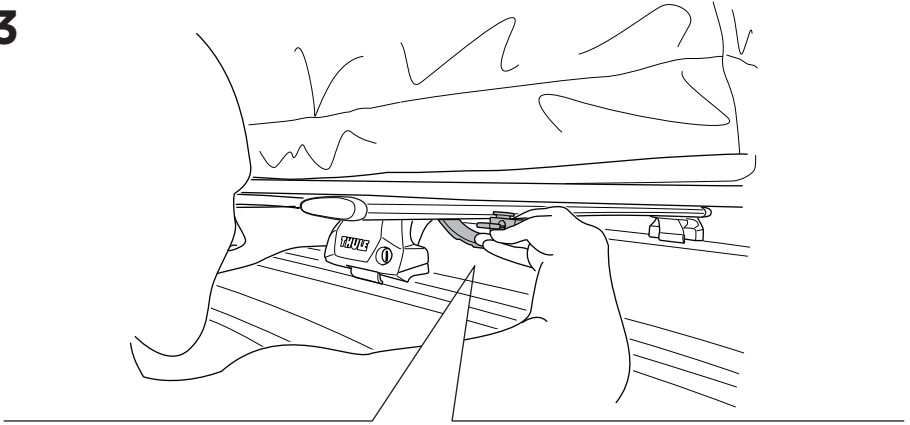

A

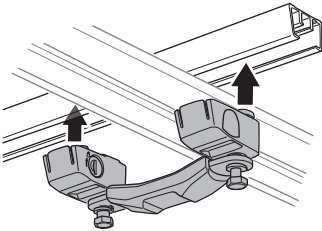

B

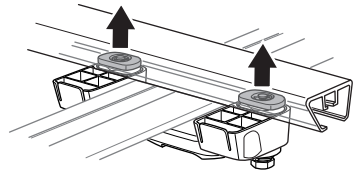

C

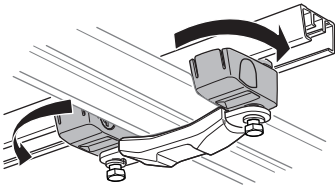

D

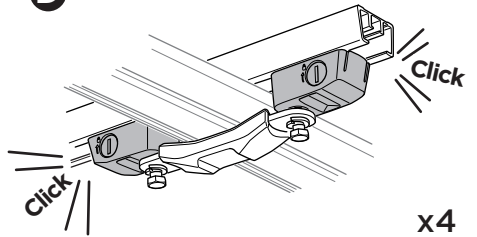

Not ok

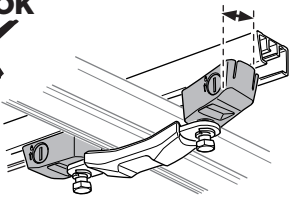

ok

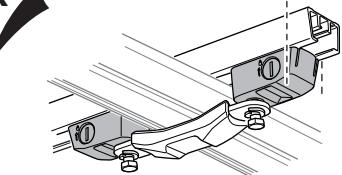

4

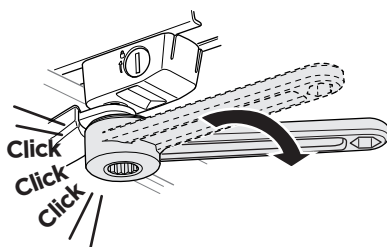
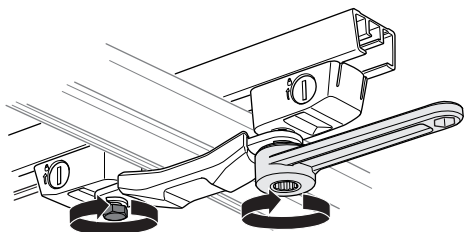
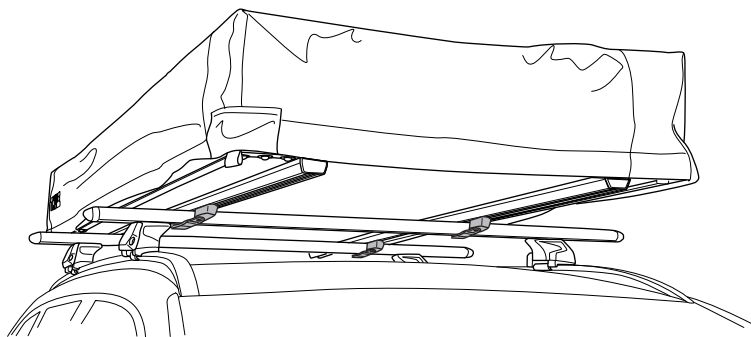

i

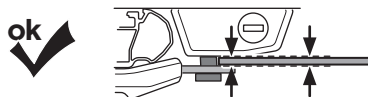
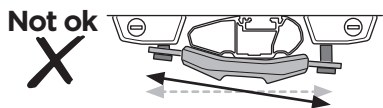
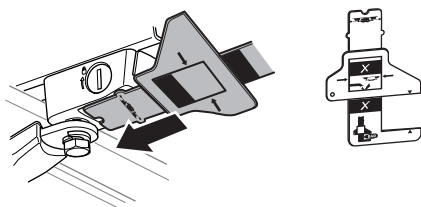
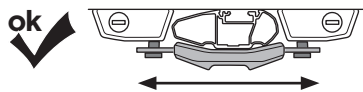

5

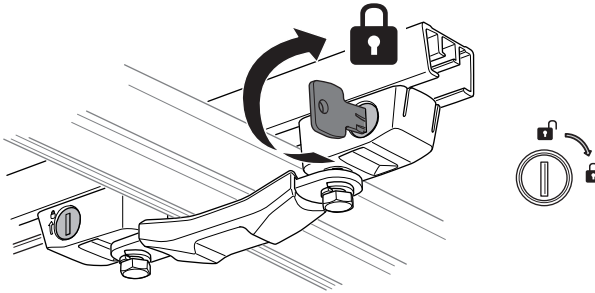

i

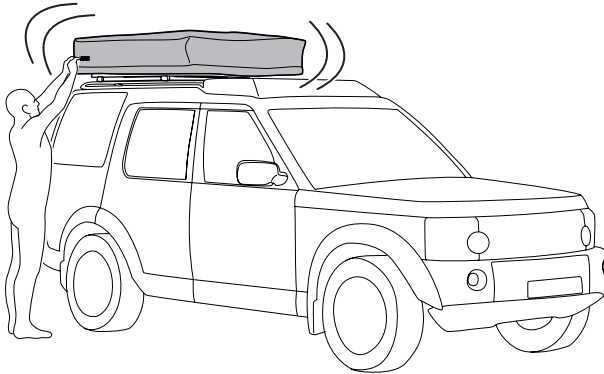

i

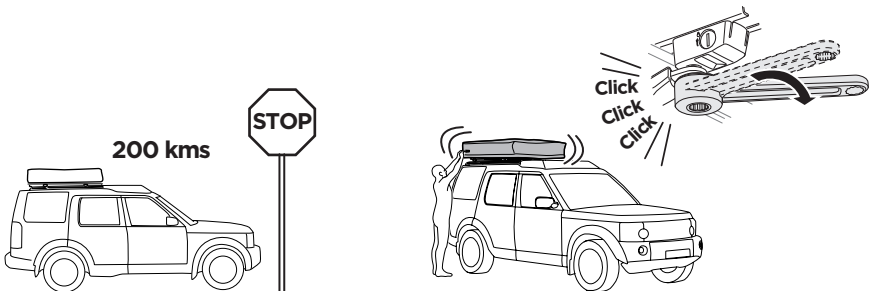

i

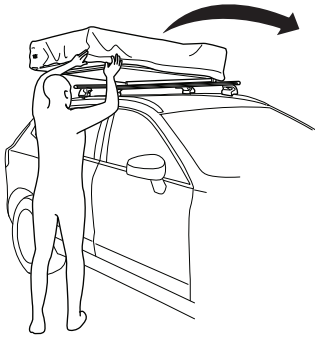

A

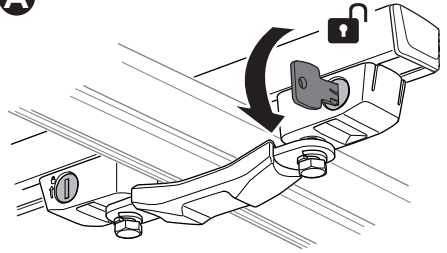

B

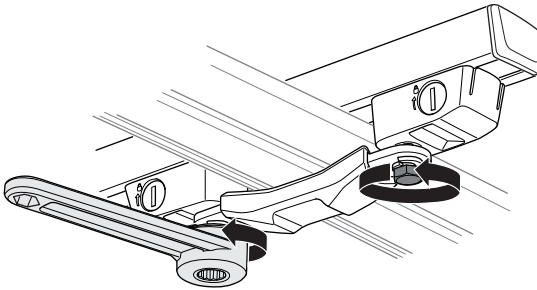

Alt II



C

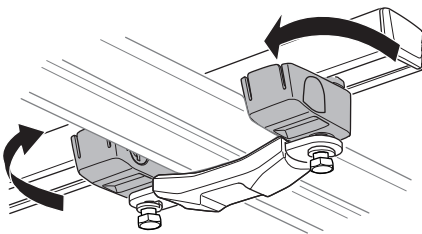

D

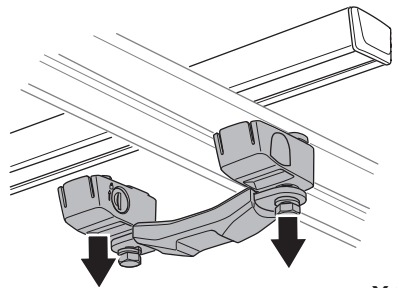

x4

EN Accessories
 FR Accessoires
 ES Accesorios
 DE Zubehör
 NL Accessoires
 PT Acessórios
 IT Accessori
 SV Tillbehör
 DK Tilbehør
 NO Tilbehør
 FI Lisävarusteet
 IS Aukabúnaður

ET Tarvikud
 LV Piederumi
 LT Priedai
 RU Аксессуары
 UK Аксесуары
 PL Akcesoria
 CS Příslušenství
 HU Kiegészítők
 RO Accesorii
 SK Príslušenstvo
 SL Dodatna oprema
 BG Аксесоари

HR Dodatna oprema
 EL Αξεσουάρ
 TR Aksesuarlar
 MT Aċċessorji

אביזרים HE
 الملحقات AR

ZH (CN) 附件
 ZH (TR) 配件
 JA アクセサリー
 KO 액세서리
 TH อุปกรณ์เสริม
 MS Aksesori

Thule One-Key System

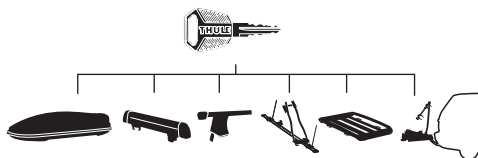

450400  (x4)

450600  (x6)

450800  (x8)

451200  (x12)

A

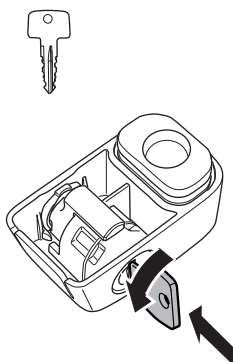

B

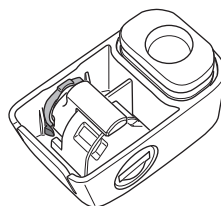

C

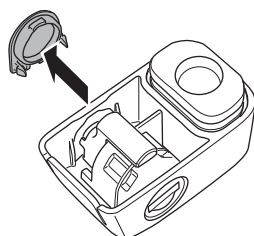

D

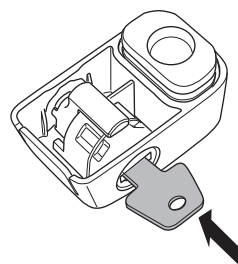

E

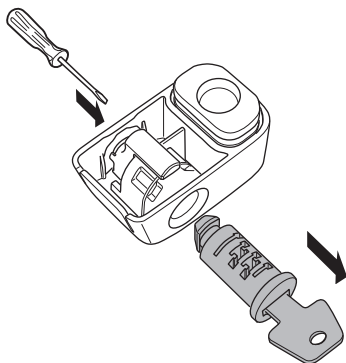

F

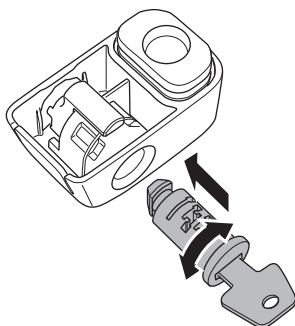

G

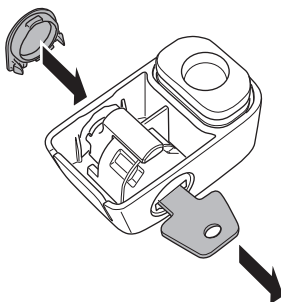

H

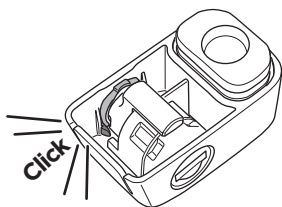

I

