

Hk-F8'5B: @9DFC >97 HC B

6G 9.	7F: 'BC.
W	\$+, '
	G+ B5H F9. 85H9.
8F5K B.	; ŽHYWJ c &- #10#%
7 < 97 ? B.	< Ž3b_QR^d &- #10#%

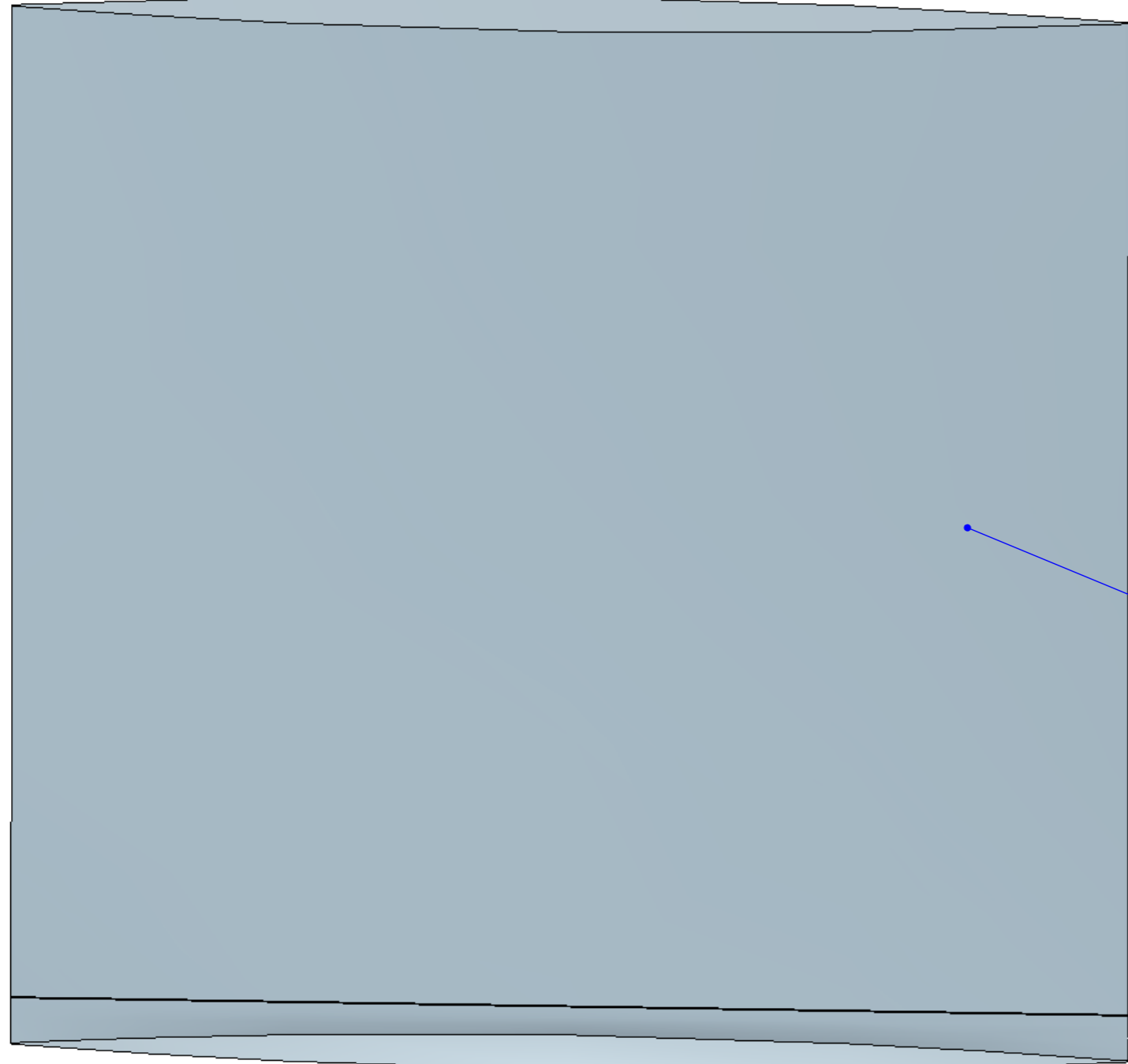

D5 &+ 'l %  
%&'l % "Dc ntl\YbY '6U[ z) \$\$;

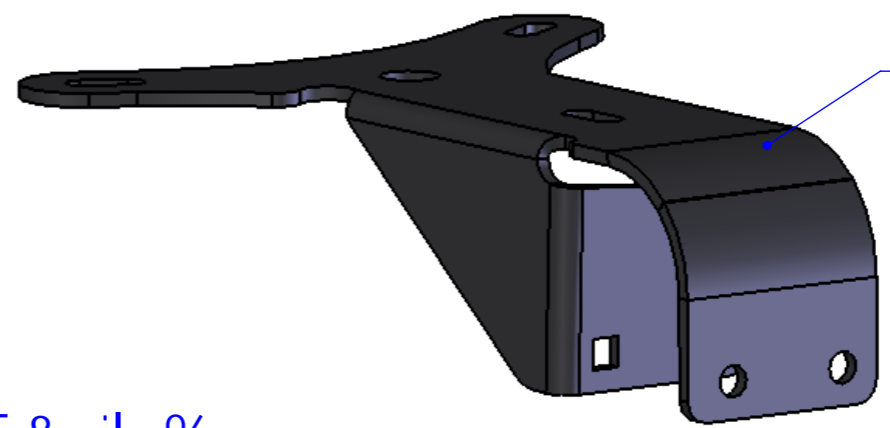

A G&&( 'l %  
6YUWc b '6fUW\_Yh

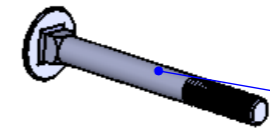

: G\$\$, 'l &  
A \* 'l \* \$a a 'Gei UY 'BYW\_7 cUW 'GWYk



: K \$\$\$%l &  
A \* 'gh5 & 'gX K Ug\_Yf



: B \$\$\$%l &  
A \* 'gh5 ( 'Bmc WBi h

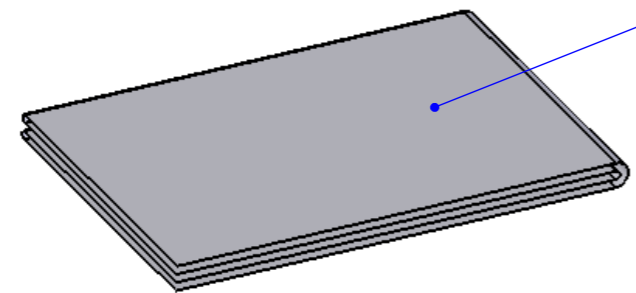

GB: ?%) ) Ql %  
7 i gca Yf-bgfI Wjcb G\YYffj

¥ BC H9: H\gXfuk jpl jgH Y'dfcdYfmcZF < BC 'DFC 8l 7 HG@X 'UbX 'a i ghbc hVY 'i gYX 'cfWcdJYX 'k jh'ci h  
k flH Yb 'Wc'bg'brH 'HY F < BC 'DFC 8l 7 HG'bUa Y 'UbX 'c[ 'c' a i ghfYa Ujb 'WYUf'mj jgV 'Y 'jb 'Ubmfy'd fc XI Wjcb



8F5K B: BC. : ?%) ) 'f/c Z&t
A 5Hf 5@GN9. b#U

89G7 F DHC B. : ]h]b[ '?]hž 6YUWc b '6fUW_Yh
A 5Hf 5@GD97. b#U

: B G<. b#U
----------------

89G+ B 98 6M >"K ]]Ua g \$, #/%\$#%
K 9= <H \$"( ' ?[

I B@GGCH: 9FK @9 GD97 = 98. 8-A 9BG€BG5F9'-B 'A A \$"\$ \$ ..... + \$"& \$"\$ \$ ..... + \$") 5B; ..... ± \$")°
89F 98 8-A 9BG€BGG<C K B 'B 6F57?9HG 896l FF'5B8 '6F95? 5@G< 5FD'98; 9G
G< 99HG^9 5' G< 99HG7 5@9.' ) ,.

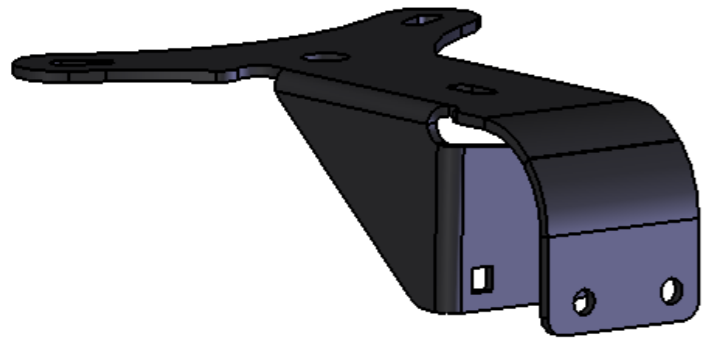

fA G&&(Ł1 %

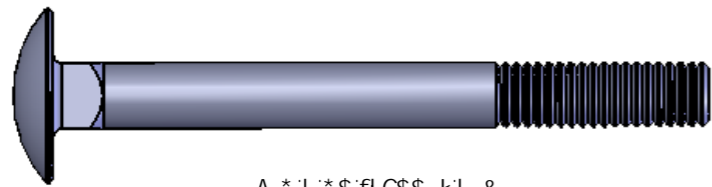

A \*1 \*\$fi G\$\$, Ł1 &

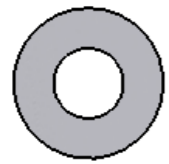

A \*fi K \$\$%&1 &



A , fi B \$\$%&1 &

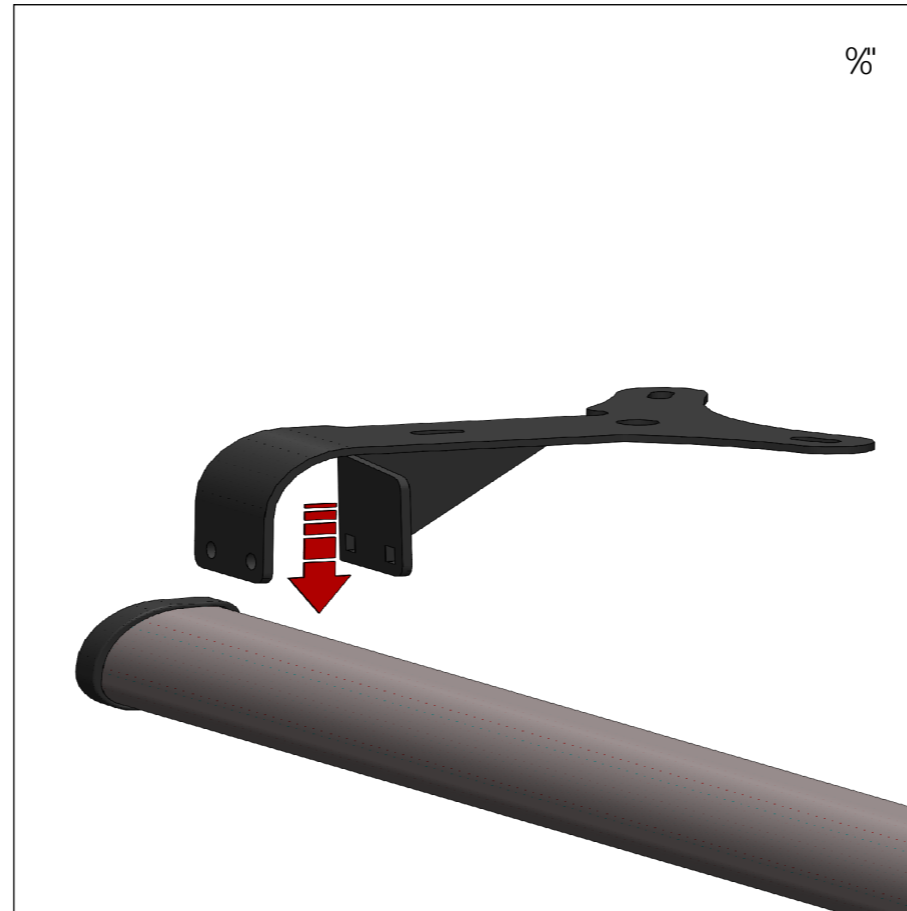

%"

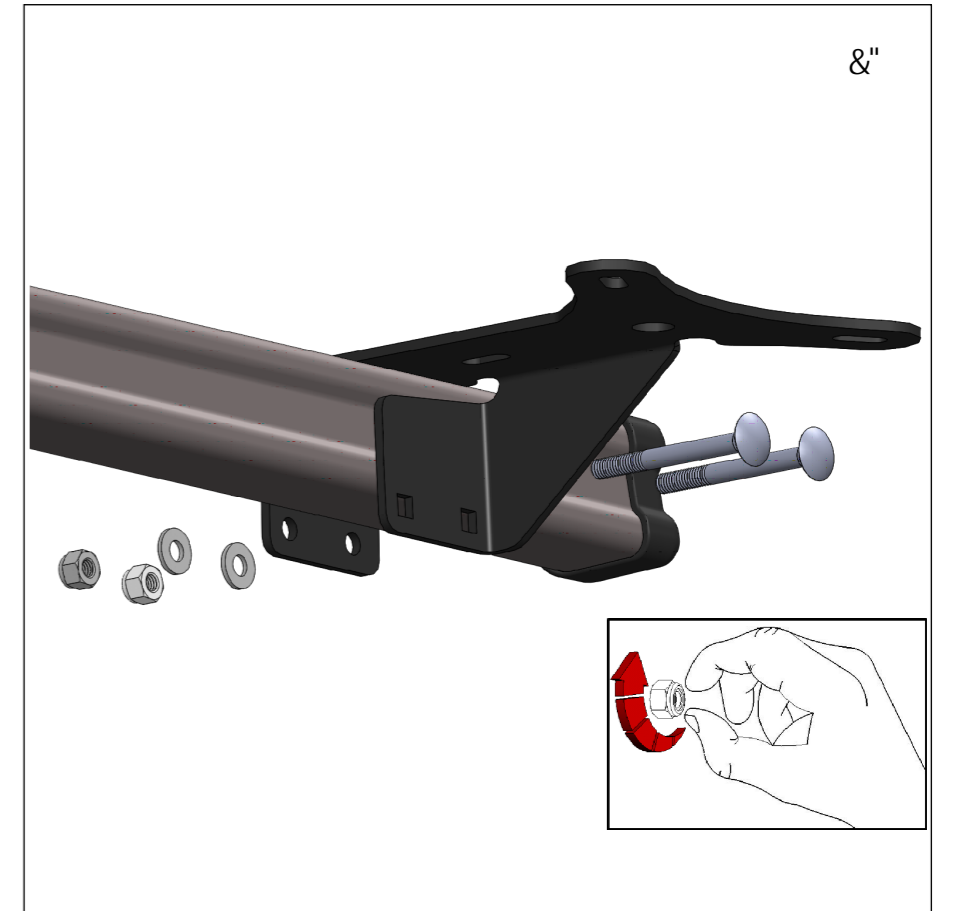

&"

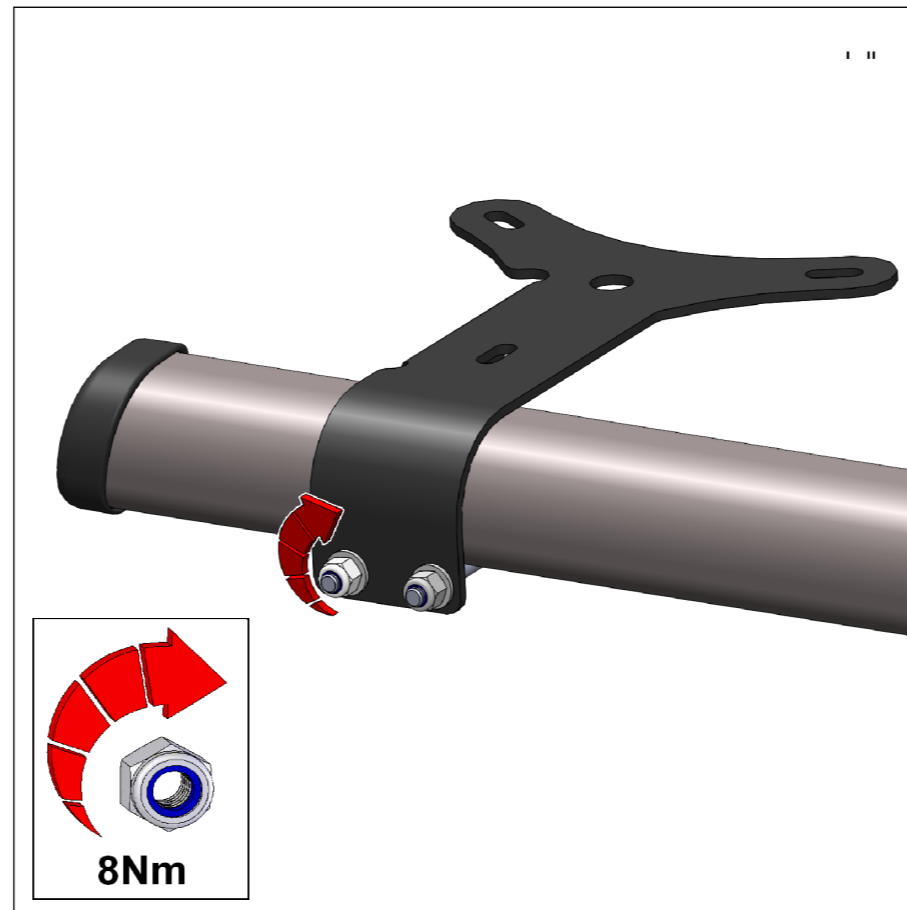

."

